

Dimensional Drawings:

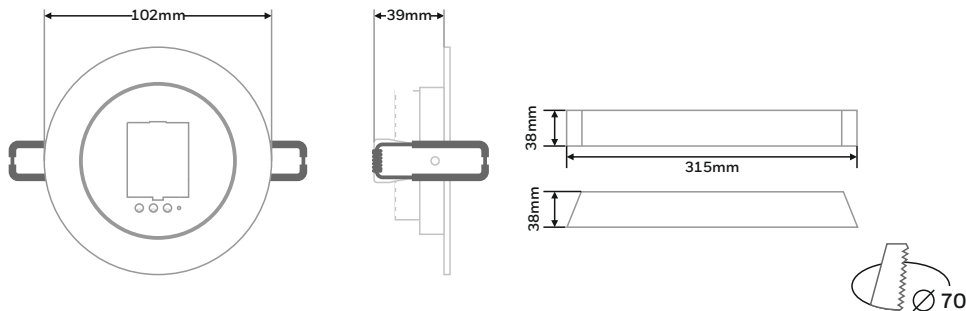

Installation:

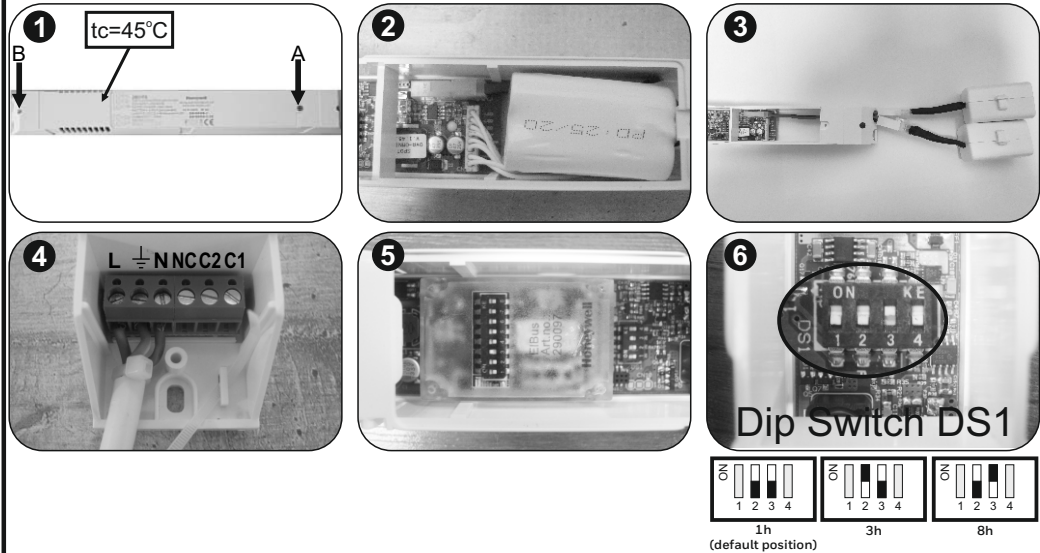

To install this luminaire, a hole $\varnothing 70$ mm must be cut in the suspended ceiling. For correct mounting, observe the light direction.

Step 1: Unfasten the mounting screws, **A** for battery compartment and **B** for electrical connections. Remove the respective covers.

Step 2: Connect the battery and place the battery inside the compartment. Refit the cover and fasten the removed screw (**A**) in step 1.

Step 3: For accomplishing 8h autonomous light, Part No. 290BAT.10 is required. To install, follow the extra installation manual of the Part No. 290BAT.10.

Step 4: Connect the mains cables to the terminal blocks. **L** for live wire **N** for neutral. The ground terminal is optional. Power supply cables cross section should be 0.8 – 3 mm². The **C1** and **C2** terminals are used for eIBus communication (optional), DALI communication (optional) or voltage free contact (optional). After the connection of the cables, secure them with the provided ties. Refit the cover (**B**) and fasten the removed screw in step 1.

Step 5: In case you use a module connect it on the PCB.

Step 6: The user can select one of the 3 available minimum autonomy durations: 1 hour, 3 hours and 8 hours. The selection must be done while the luminaire is disconnected from AC and battery supplies. The selection is achieved through Switches 2 & 3 of DS1 according to image above. Switches 1 and 4 are not used. One additional label is included in the package for 3 hours duration (180), the installer must cover the default 1 hour (60) printing. **Please take notice of the orientation of the label.**

Battery replacement:

Disconnect mains, carefully pull the luminaire and main unit down, make sure that the springs do not snap. Unscrew the battery cover (step 1 of installation procedure, screw **A**). Disconnect the battery and install a new one of the same type and characteristics. Refit the cover and fasten the screw.

Spot Installation:

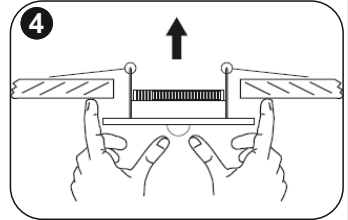
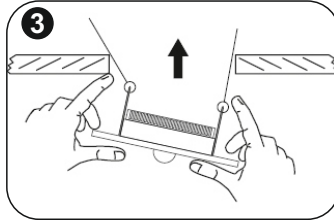
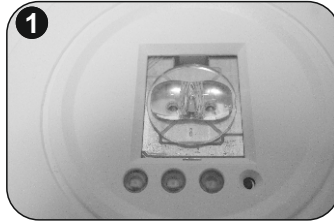
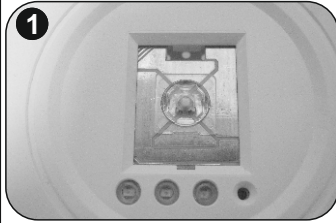

In order to place the proper lens (Anti - panic or escape route), first be sure that the luminaire is not connected in the mains power supply and the battery is disconnected. A 5 lux lens (Part no. 2900XX.STR) is also available for order. Be careful not to touch the LED with your hand.

Step 1: Place the proper lens (Anti - panic or escape route) on the luminaire.

Step 2: Place the proper retaining cover (Anti - panic or escape route) on the luminaire.

To install the spot place the main unit on the false ceiling and follow the next steps.

Step 3: Bend one spring, to get into the holes of the suspended ceiling.

Step 4: Bend the other spring and push the luminaire upwards until it is securely mounted. The device is now ready to operate. The TEST button is located next to the indication diodes.

Important notice when installing luminaires within the same area!!!

To avoid that luminaires perform their battery test at the same day, connect the battery packs with more than 1,5 minutes inbetween.

Note: In case of mains power disconnection for a period of more than two months, the battery must be disconnected.

Note: In case of battery replacement, this must be replaced with parts of the same type and characteristics. The replacement must be performed by the manufacturer or a competent person.

Note: If the supply cable of the luminaire is damaged, it shall exclusively be replaced by a competent person in order to avoid hazard.































 The light source contained in this luminaire shall only be replaced by the manufacturer, or his agent, or a similar qualified person.

NOTE! The light source is non-user replaceable.



At the end of their useful life the packaging, product and batteries should be disposed of via a suitable recycling centre. Do not dispose of with your normal household waste. Do not burn.



Indicator LEDs	Description	Technical description	
		Ova-OmniLED R Spot ER/AP NM ST LED 230V 138h	
		Part no.:	138007
		Operation Voltage:	220-240V AC, 50-60 Hz
		Maximum Power Consumption:	1h & 3h: 3.4W / 3.9VA 8h: 5W / 5.3VA
		Battery (NiMH):	1h & 3h: 4.8V / 1.2Ah 8h: 2x 4.8V / 1.2Ah
		Battery Protection:	Overcharge protection / deep discharge protection
		Min./Max. Charge Current:	1h & 3h: 40 / 120mA 8h: 80 / 160mA
		Charge Voltage Range:	4 - 6V
		Charging Time:	1h & 3h: 16 hours 8h: 24 hours
		Insulation between supply & battery circuit	Basic Insulation
		Emergency Mode Duration:	1h / 3h / 8h manually selected (default 1h)
		Lumen output, emergency:	1h: 360lm / 3h: 170lm / 8: 145lm
		Produced in accordance with:	EN 60598-1, EN 60598-2-22, EN 55015 EN 61547, EN 61000-3-2, EN 61000-3-3
		Ambient Temperature Range:	5 to 40 °C
		Relative Humidity:	Up to 95%
		Degress of cover protection:	IP20
		Technical lifetime (light source):	> 100000 hours
		Weight:	459 gr
		Expected Battery Lifetime:	4 years
		Controlgear classification in accordance with IEC 62034: with automatic test function	
		The controlgear is proof against supply voltage polarity reversal	
		The controlgear has mains-connected windings of transformer	
		Light source: 1 power LED, Model number: 3107195, 2210195, wattage: 2.3~2.5W	
GREEN  YELLOW  RED 	Normal    Charging (battery test not possible while charging)    Mains off (battery not connected or charger fault)    Battery test    Battery fault    Light source test    Light source fault    Battery fault and light source fault   	LED Status explanation  Off  On  Flashing	

The **Ova/OmniLED R Spot** is a self-contained non-maintained luminaire with selftest function.

Selftest functions

Every 15 days the luminaire will perform an emergency operation test. This will light the white LED for approximately 3 seconds. The red LED will flash during this test sequence.

Every 6 months the luminaire will perform a battery condition test. The test will last for the stated duration. The white LED will be lit and the yellow LED will flash during this test sequence.

Note: When using DALI or Wireless communication, the frequencies and schedules for tests will instead be determined by the connected PC software.

Manual test functions

Manual tests can only be performed if both mains and battery are connected.

By pressing the test button briefly (less than 5 seconds) an emergency operation test is performed. The white LED will be lit for approximately 3 seconds, the red LED will flash during this test sequence.

By pressing the test button for between 5 and 10 seconds a battery condition test is performed. This test will last for the stated duration and can only be performed when the battery is fully charged (steady green LED). The white LED will be lit and the yellow LED will flash during this test sequence.

Resetting errors

Push the test button for >10 seconds to delete all indicated errors. Then the luminaire enters regular operation mode.